

MAQUINA	DESCRIPCION
QCGCN3522	GRAPADORA 35-22 MAN.NEUM.

DESDE FECHA	13/07/20
HASTA FECHA	31/12/2099

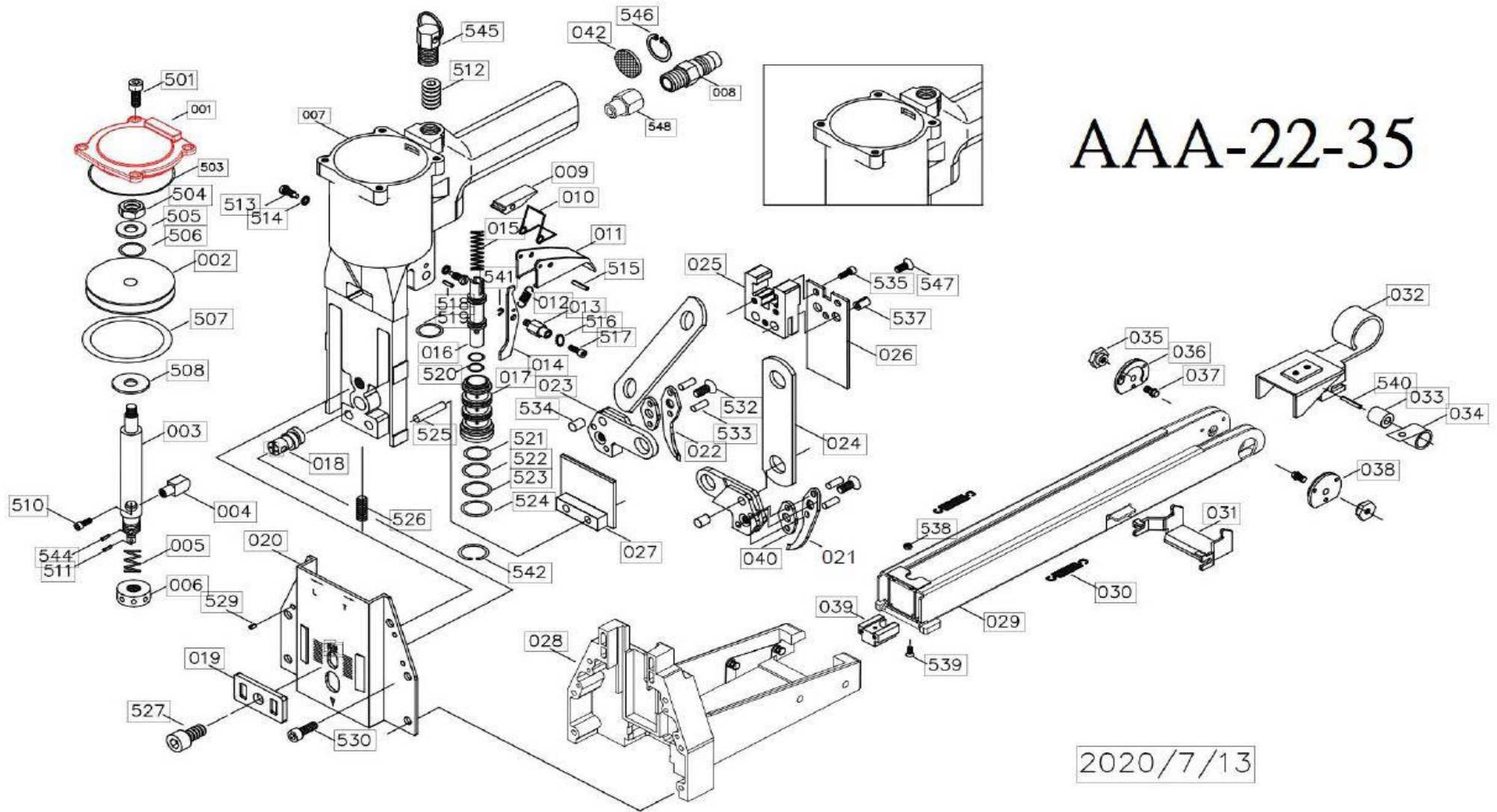

AAA-22-35

2020/7/13



MAQUINA	DESCRIPCION	DESDE FECHA	13/07/2020
QCGCN3522	GRAPADORA 35-22 MAN.NEUM.	HASTA FECHA	31/12/2099

RECAMBIO	DESCRIPCION	CANTIDAD	POSICION
RM02A01200114 (001)	TAPA A01200114	1	1
RM02A02800201 (002)	PISTÓN A02800201	1	2
RM02A02800301 (003)	EJE A02800301	1	3
RM02A00100401 (004)	TUERCA A00100401	1	4
RM02A00100501 (005)	MUELLE A00100501	1	5
RM02A00100601 (006)	TUERCA A00100601	1	6
RM02ADCSP31 (007)	CUERPO ADCS-P31	1	7
RM02A00100803 (008)	ENTRADA AIRE A00100803	1	8
RM02A00100902 (009)	LEVA A00100902	1	9
RM02A00101001 (010)	MUELLE A00101001	1	10
RM02A00101101 (011)	GATILLO A00101101	1	11
RM02A00101201 (012)	MUELLE A00101201	1	12
RM02A00101301 (013)	TUERCA A00101301	1	13
RM02A00101402 (014)	LEVA A00101402	1	14
RM02A00101501 (015)	MUELLE A00101501	1	15
RM02A00101603 (016)	VÁLVULA A00101603	1	16
RM02A00101702 (017)	VÁLVULA A00101702	1	17
RM02A00101801 (018)	AMORTIGUADOR A00101801	1	18
RM02A00101901 (019)	PLACA A00101901	1	19
RM02A01102501 (020)	PLACA A01102501	1	20
RM02A01200501 (021)	UÑA A01200501	1	21
RM02A01200601 (022)	UÑA A01200601	1	22
RM02A00102301 (023)	SOPORTE A00102301	1	23
RM02A00102401 (024)	GUÍA A00102401	1	24
RM02A00102502 (025)	UÑA A00102502	1	25
RM02A01201708 (026)	CUCHILLA A01201708	1	26
RM02A00102703A (027)	SOPORTE A00102703A	1	27



MAQUINA	DESCRIPCION	DESDE FECHA	13/07/2020
QCGCN3522	GRAPADORA 35-22 MAN.NEUM.	HASTA FECHA	31/12/2099

RECAMBIO	DESCRIPCION	CANTIDAD	POSICION
RM02A02100407A (028)	CARCASA A02100407A	1	28
RM02HAA1935P7SD (029)	CARGADOR HAA-19-35-P7-SD	1	29
RM02A01102403 (030)	MUELLE A01102403	1	30
RM02A01102201 (031)	GANCHO A01102201	1	31
RM02A00103709A (032)	EMPUJADOR A00103709A	1	32
RM02A00103501 (033)	RODILLO A00103501	1	33
RM02A00103401 (034)	FLEJE A00103401	1	34
RM02A00607101 (035)	TUERCA A00607101	1	35
RM02A00103903A (036)	GUÍA A00103903A	1	36
RM02A00103203 (037)	RODILLO A00103203	1	37
RM02A00103904A (038)	GUÍA A00103904A	1	38
RM02A00607502 (039)	SOPORTE A00607502	1	39
RM02A00105001 (040)	ARANDELA A00105001	1	40
RM02BAI1401 (042)	SILENCIADOR BAI1401	1	42
RM02BAC0604142 (501)	TORNILLO BAC0604142	1	501
RM02BAB017537 (503)	ANILLO TÓRICO BAB017537	1	503
RM02BAD02061 (504)	TUERCA BAD02061	1	504
RM02BAE06094 (505)	ARANDELA BAE06094	1	505
RM02BAB017076 (506)	ANILLO TÓRICO BAB017076	1	506
RM02BAB057476 (507)	ANILLO TÓRICO BAB057476	1	507
RM02A00104101 (508)	ARANDELA A00104101	1	508
RM02BAC0604102 (510)	PERNO BAC0604102	1	510
RM02BAA025014 (511)	PASADOR BAA025014	1	511
RM02BAC0312122 (512)	MUELLE BAC0312122	1	512
RM02A00104401 (513)	TORNILLO A00104401	1	513
RM02BAE01042 (514)	ARANDELA BAE01042	1	514
RM02BAA030020 (515)	PASADOR BAA030020	1	515



MAQUINA	DESCRIPCION	DESDE FECHA	13/07/2020
QCGCN3522	GRAPADORA 35-22 MAN.NEUM.	HASTA FECHA	31/12/2099

RECAMBIO	DESCRIPCION	CANTIDAD	POSICION
RM02BAE02042 (516)	ARANDELA BAE02042	1	516
RM02BAC0404102 (517)	TORNILLO BAC0404102	1	517
RM02BAA030010 (518)	PASADOR BAA030010	1	518
RM02BAB017124 (519)	ANILLO TÓRICO BAB017124	1	519
RM02BAB017076 (520)	ANILLO TÓRICO BAB017076	1	520
RM02BAB016145 (521)	ANILLO TÓRICO BAB016145	1	521
RM02BAB016150 (522)	ANILLO TÓRICO BAB016150	1	522
RM02BAB016155 (523)	ANILLO TÓRICO BAB016155	1	523
RM02BAB016160 (524)	ANILLO TÓRICO BAB016160	1	524
RM02A00104701 (525)	PASADOR A00104701	1	525
RM02BAC0306142 (526)	TORNILLO BAC0306142	1	526
RM02BAC0608162 (527)	TORNILLO BAC0608162	1	527
RM02BAA030010 (529)	PASADOR BAA030010	1	529
RM02BAC0605142 (530)	PERNO BAC0605142	1	530
RM02A00106201 (532)	TORNILLO A00106201	1	532
RM02A00104501 (533)	PASADOR A00104501	1	533
RM02A00104602 (534)	PASADOR A00104602	1	534
RM02BAC0604102 (535)	PERNO BAC0604102	1	535
RM02BAA060016R (537)	PASADOR BAA060016-R	1	537
RM02BAD01041 (538)	TUERCA BAD01041	1	538
RM02BAC0404202 (539)	TORNILLO BAC0404202	1	539
RM02BAA040016 (540)	PASADOR BAA040016	1	540
RM02BAF10252 (541)	CER-CLIP BAF10252	1	541
RM02BAF22002 (542)	CER-CLIP BAF22002	1	542
RM02A00104901 (544)	PASADOR A00104901	1	544
RM02C0011201A (545)	GANCHO C0011201A	1	545
RM02BAF22002 (546)	CER-CLIP BAF22002	1	546



MAQUINA	DESCRIPCION	DESDE FECHA	13/07/2020
QCGCN3522	GRAPADORA 35-22 MAN.NEUM.	HASTA FECHA	31/12/2099

RECAMBIO	DESCRIPCION	CANTIDAD	POSICION
RM02BAC0204062 (547)	TORNILLO BAC0204062	1	547
RM02BAI1305 (548)	REDUCCIÓN BAI1305	1	548